

WHY IS CURVE DRILLING
SO HARD? IT IS JUST AN
ARC!

Forward-looking Statements

This presentation contains projections and other forward-looking statements within the meaning of Section 27A of the U.S. Securities Act of 1933 and Section 21E of the U.S. Securities Exchange Act of 1934. These projections and statements reflect the Company's current views with respect to future events and financial performance. No assurances can be given, however, that these events will occur or that these projections will be achieved, and actual results could differ materially from those projected as a result of certain factors. A discussion of these factors is included in the Company's periodic reports filed with the U.S. Securities and Exchange Commission.



Contact:

Mark Burford

Director of Capital Markets

Cimarex Energy Co.

1700 Lincoln Street, Suite 1800

Denver, CO 80203

303-295-3995



Challenges in the Curve

- Too many runs (tool failures, build rates, BHA, insert bits, etc)
- Inconsistent build rates
- Slow ROP / limited life with insert bits
- Tight target window to hit

Objectives

- Improve ROP
- Ultimate goal 1 curve bit
- Dream Goal 1 bit from KOP to TD of well

2007 Days to Drill the Curve

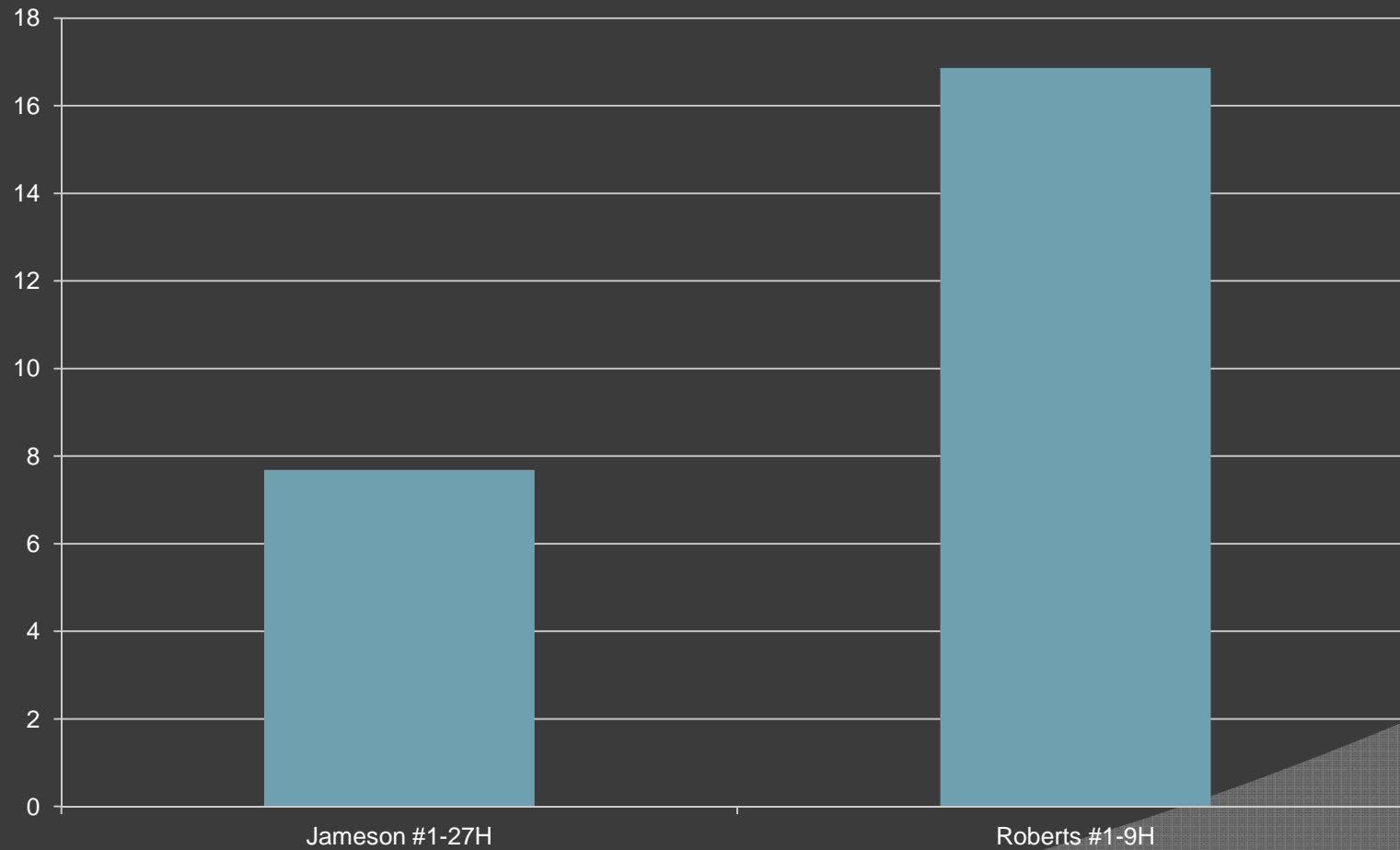

2008 Days to Drill the Curve

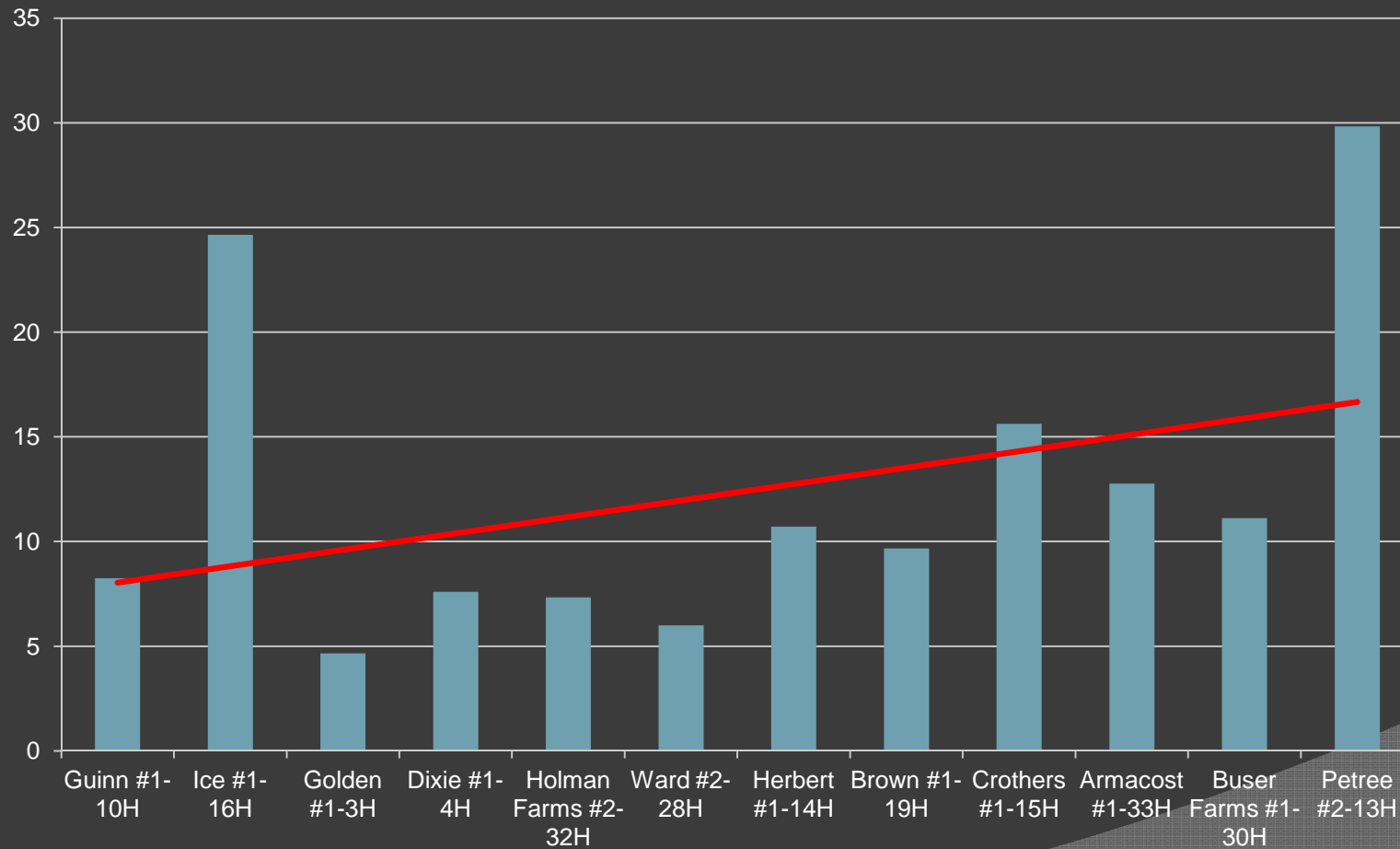

2009 Days to Drill the Curve

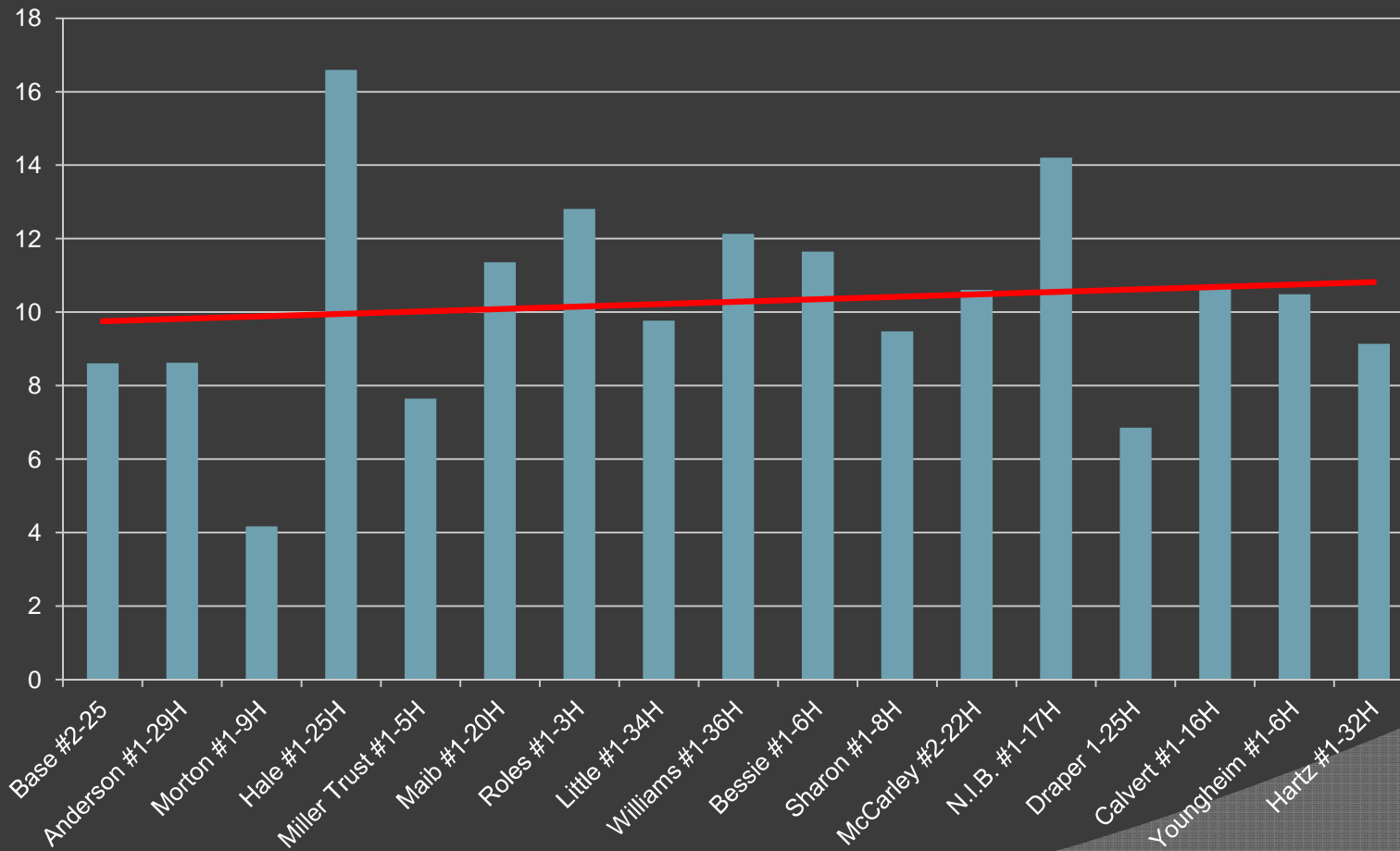

2010 Days to Drill the Curve

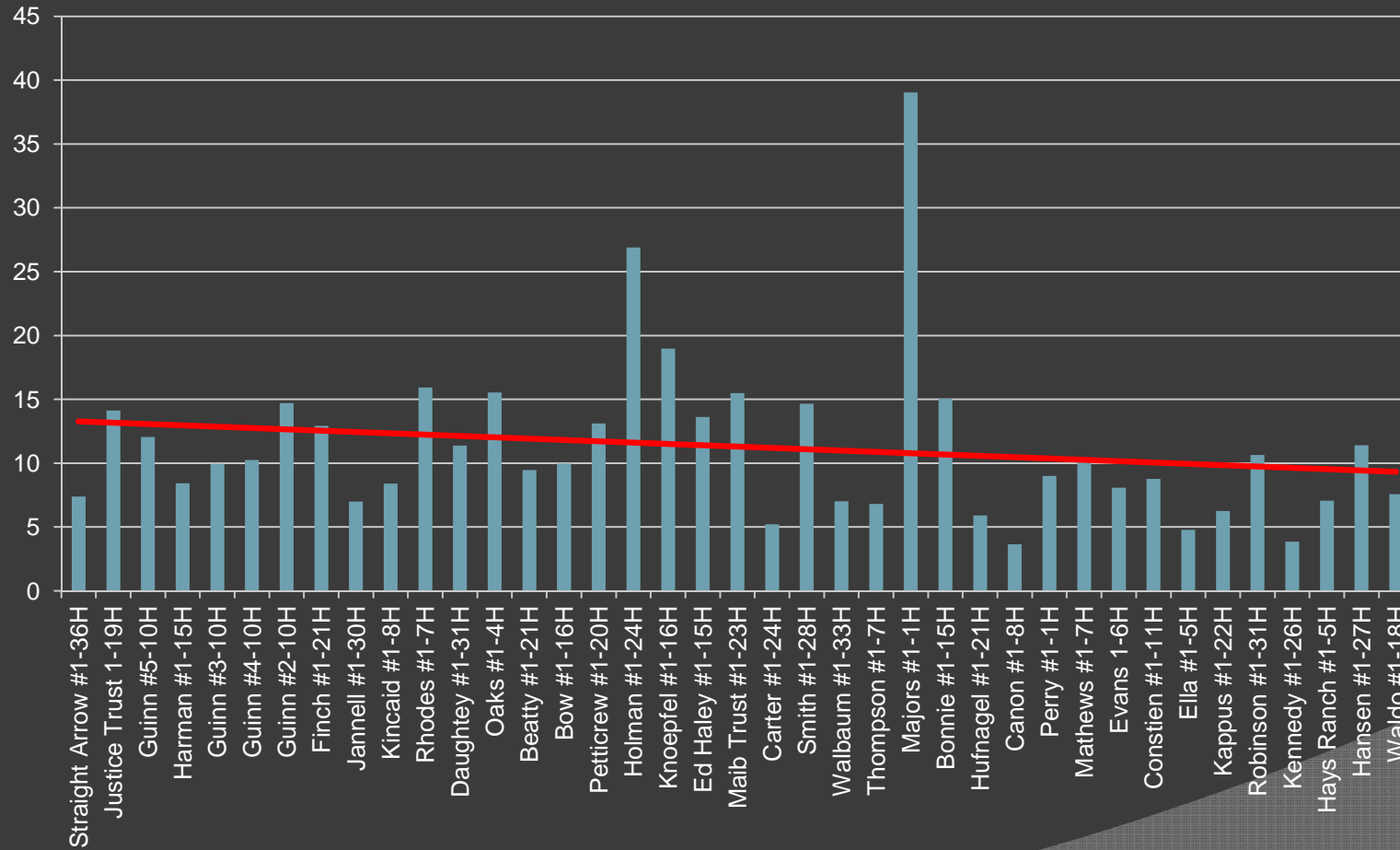

2011 Days to Drill the Curve

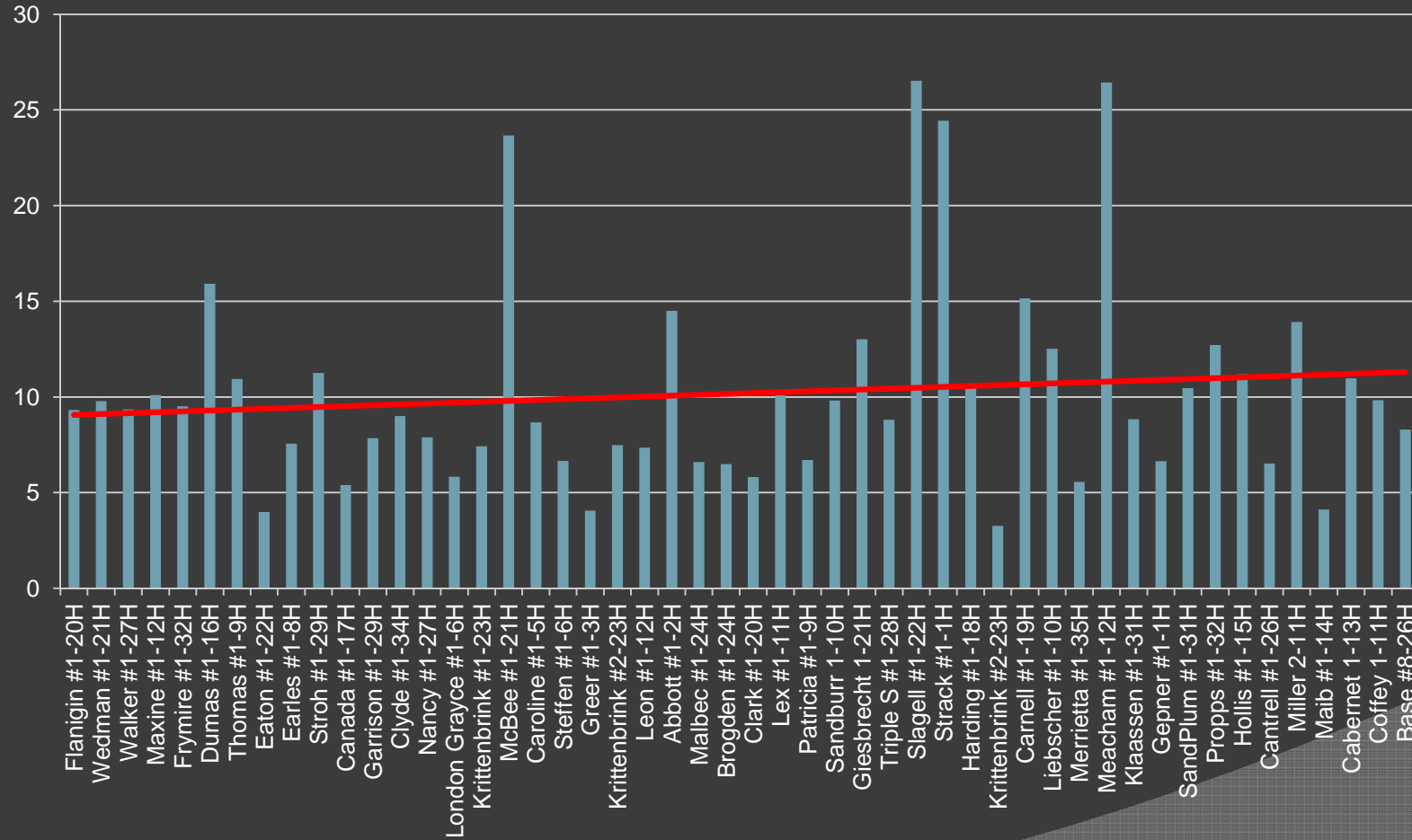

Total # of Days to Drill Curve

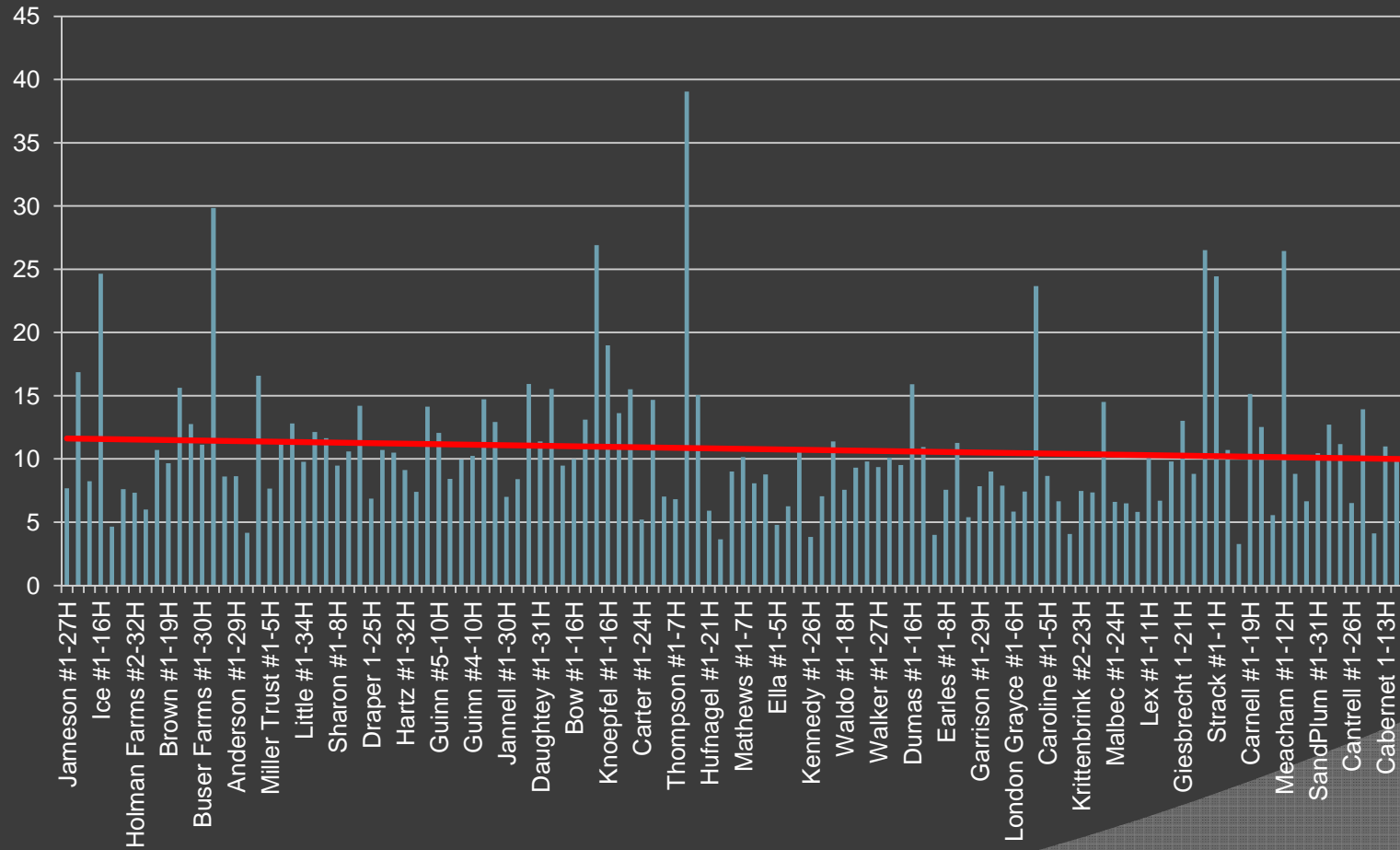

History of the Curves

	Segment Time (Days)	Rotating Hrs	Length (ft)	# TCI Bits	# PDC Bits	Total Bits	Build Rate (Deg/100')	ROP (ft/hr)	Efficiency (%)
2007	12.28	186	1,082	3.5	3.0	5	8.6	6.4	62.7
2008	11.31	150	940	3.0	2.6	4.2	11.3	6.4	62.4
2009	10.81	146	937	2.2	2.6	3.8	9.9	6.7	57.3
2010	11.32	152	1,117	2.4	1.8	3.2	8.7	8.5	57.8
2011	10.21	128	975	1.4	2.4	2.3	9.6	9.0	54.8
All In	10.81	142	1,009	2.2	2.3	3.0	8.9	7.1	54.7

Previously Used Motor BHA for Curve

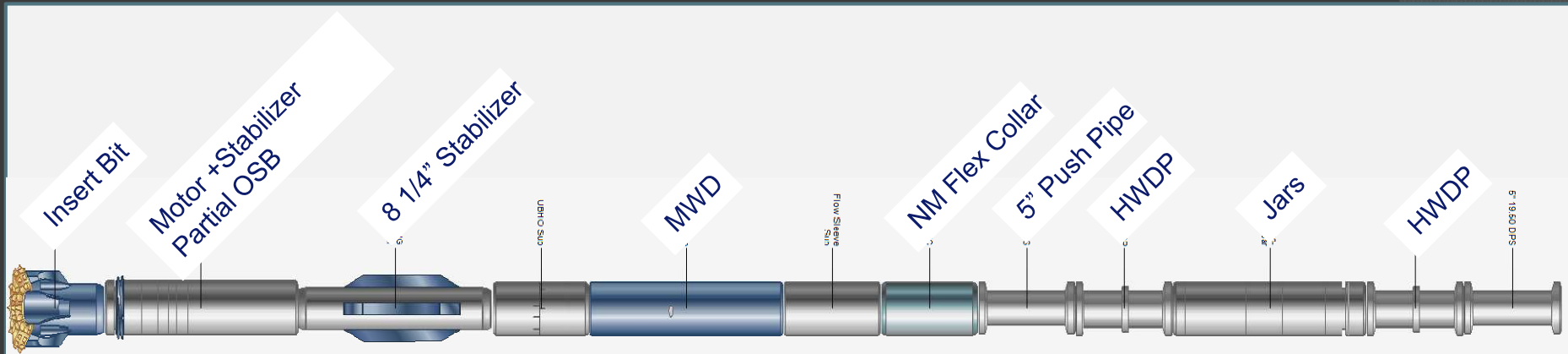

⦿ Positives

- Good toolface control
- Simple proven BHA with few components

⦿ Negatives

- Life of insert bit
- Lower ROP
- Inconsistent build rates

Review Process

- Review number of runs in the curve
- Capture lessons learned from best to worst – ROP ranking
- Comparison of rotate/slide ROP of motor & RSS
- Review of bit performance

Number of Wells	Total Number of Runs in Curve	Median Curve Runs	Average Curve ft	Shortest Curve ft	Longest Curve ft	Median Curve ft
35	149	4	1128	584	2112	978

Number of Runs per Well

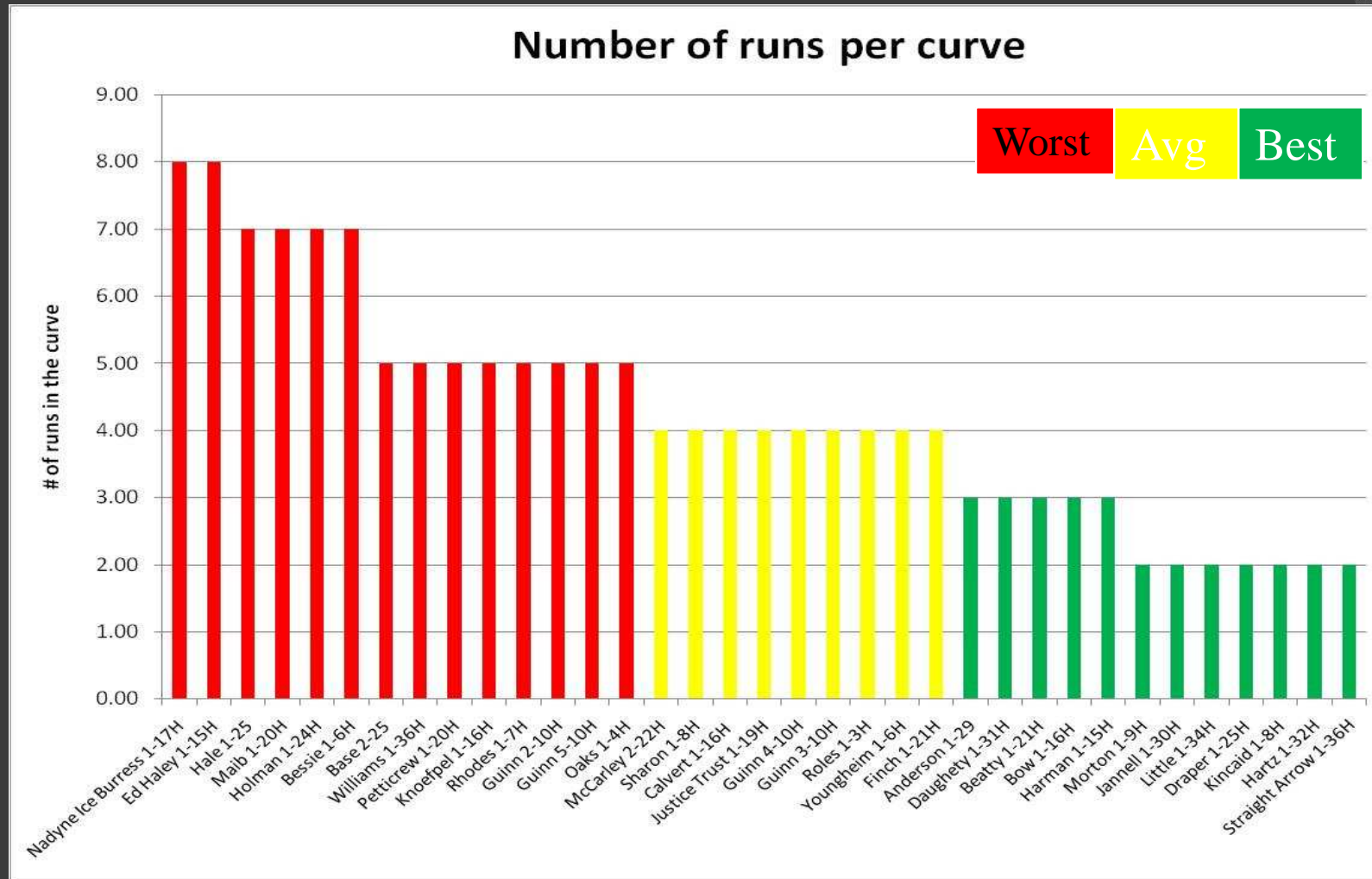

Curve DLS ROP Comparison

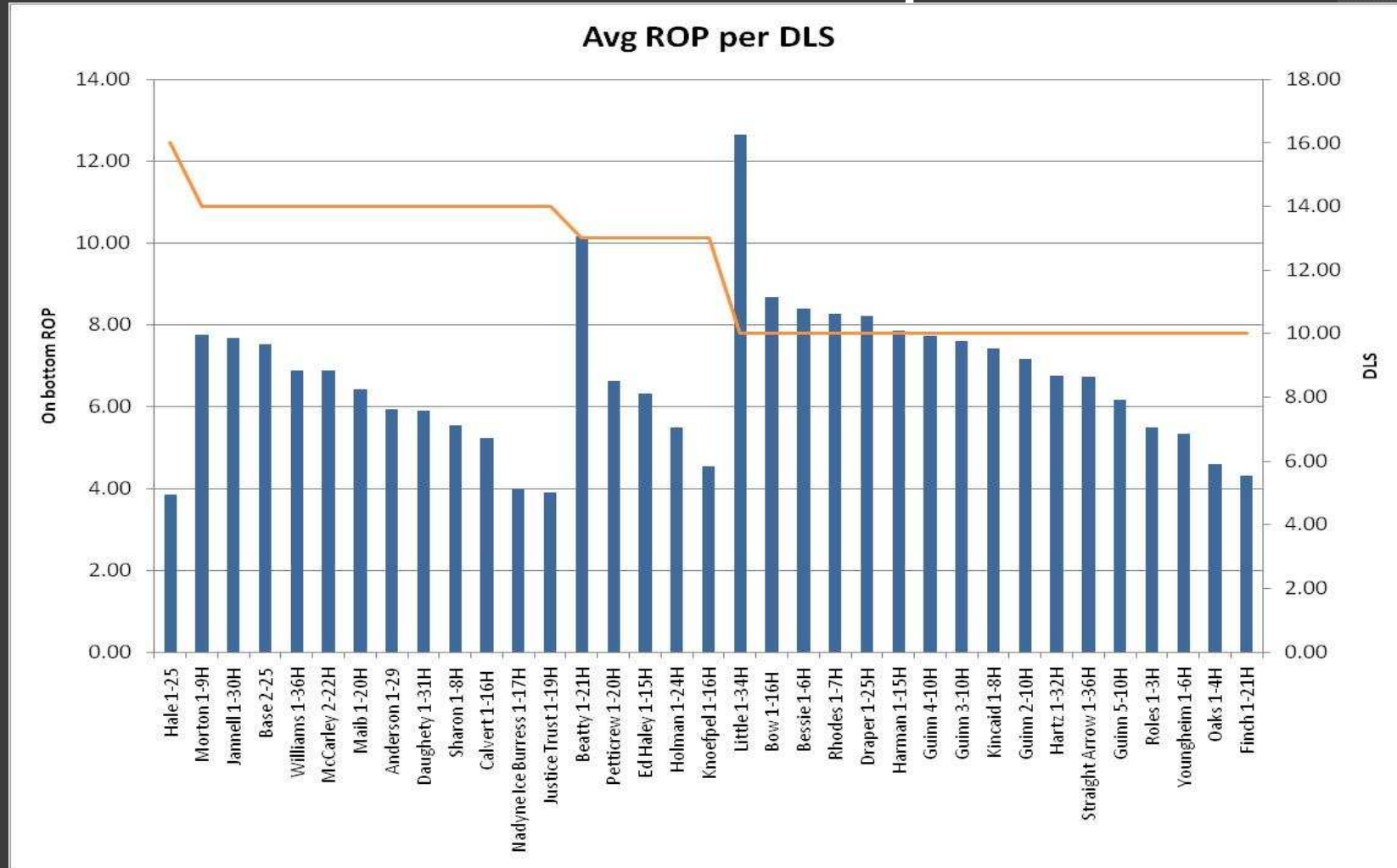

Curve BHA Evolution – Motor with PDC bit and Agitator

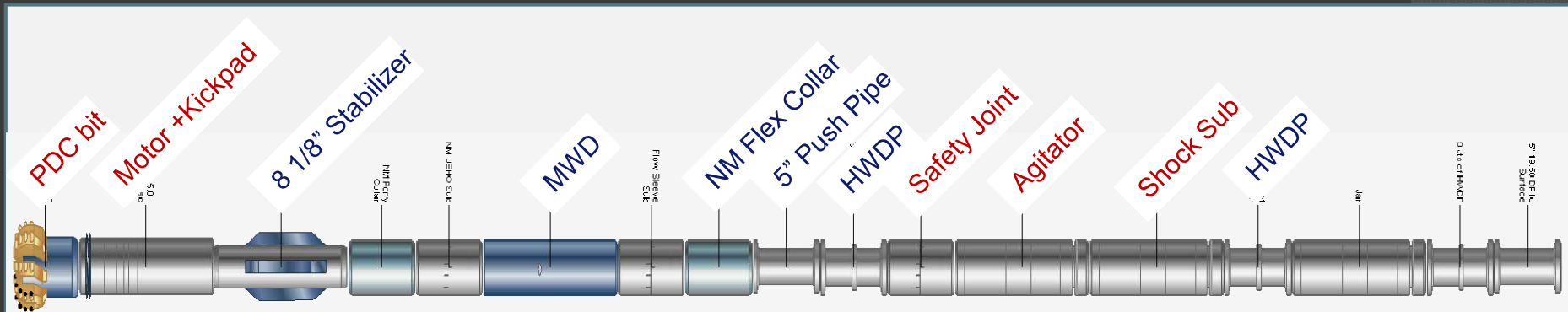

⦿ Positives

- Higher ROP with PDC bit
- Better weight transmission to bit
- Less hang up issue due to partial coverage of kick pad

⦿ Negatives

- More components in the string
- Higher system pressure
- More difficult toolface control

Agitator Effectiveness in Curve

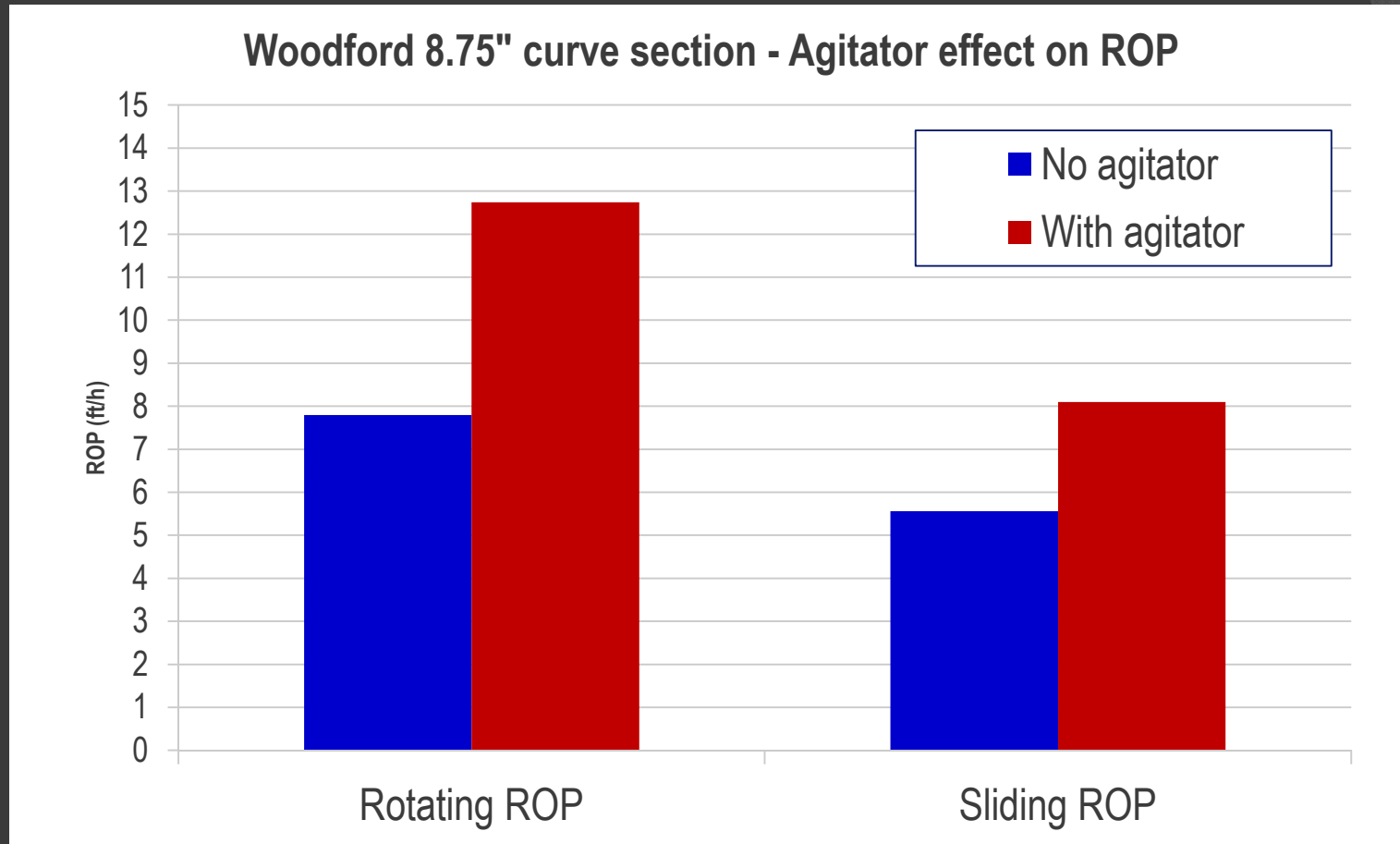

Curve BHA Evolution – High Build Rate RSS

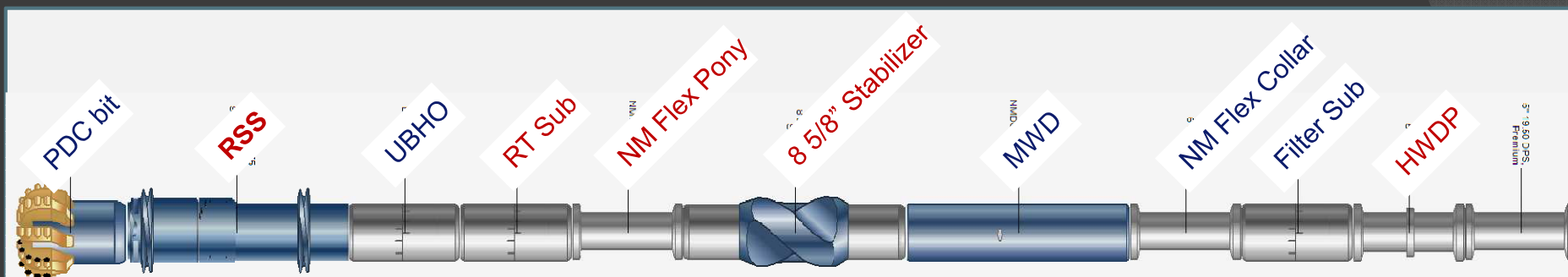

Positives

- Higher ROP due to 100% Rotating
- Smoother borehole
- Observed higher ROP in lateral vs. bent motor curve

Negatives

- Need high RPM to deliver performance
- Drillstring fatigue a possible issue if slow ROP

Ave ROP's from change

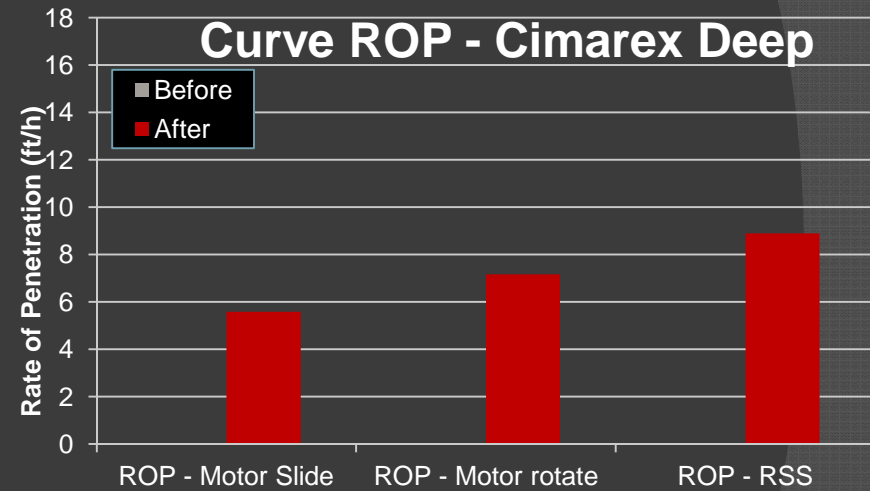
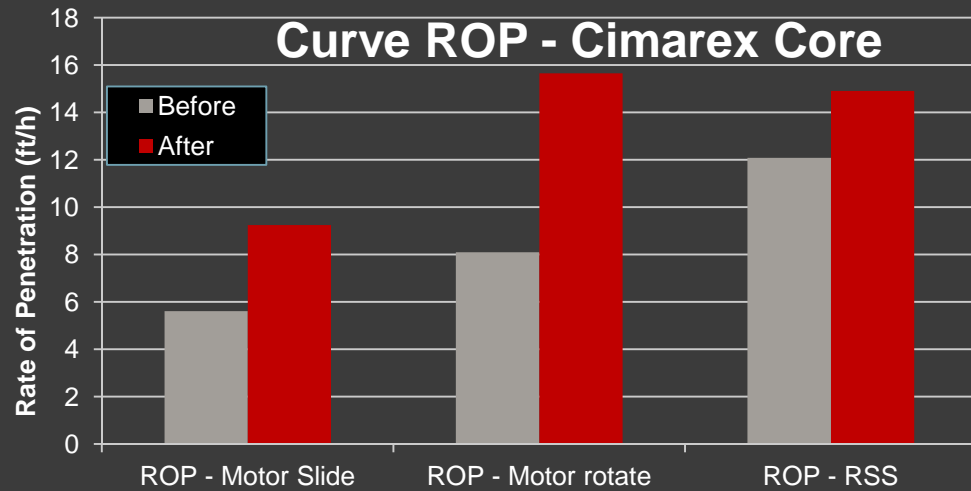

PDC vs. Tri-Cone

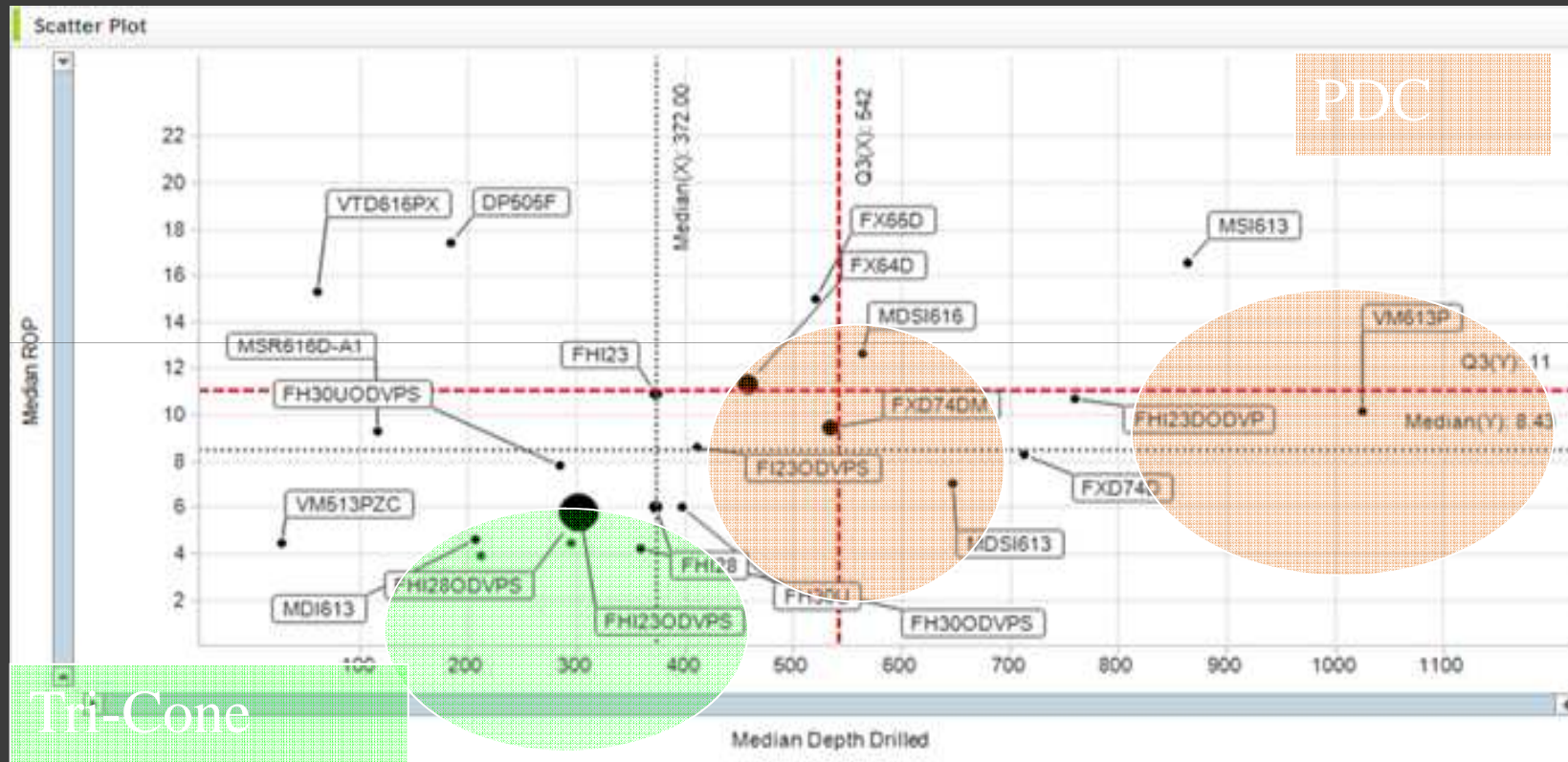

Conclusion

- ⦿ Agitator helps improve ROP in curve
- ⦿ PDC is faster than Tri-Cone
- ⦿ RSS is a step change for improvement
- ⦿ We still do not understand how to be consistent

Questions?

